

L 246 x 296 mm/mm Euro-Standard/Евростандарт

(SERIE(S)/СЕРИЯ L 2530)

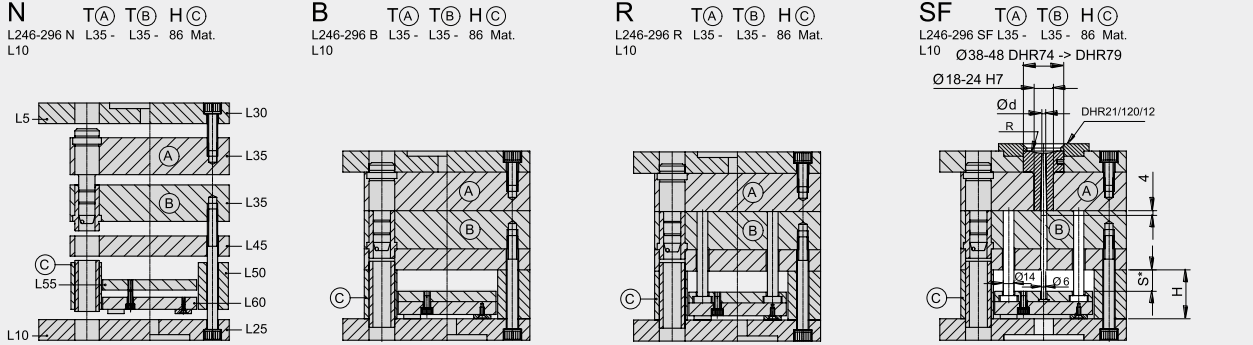

L 5/246-296

| T | DME 1 1730 | DME 3 2312 |
|----|------------|------------|
| 27 | | |
| 36 | | |
| | | |
| | | |
| | | |
| | | |
| | | |
| | | |
| | | |

L 5

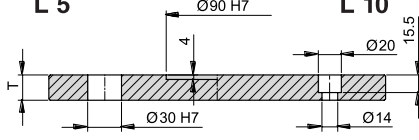

L 10

L 10/246-296

| T | DME 1 1730 | DME 3 2312 |
|----|------------|------------|
| 27 | | |
| 36 | | |
| | | |
| | | |
| | | |
| | | |
| | | |
| | | |
| | | |

L 15/246-296

| T | DME 1 1730 | DME 3 2312 |
|----|------------|------------|
| 27 | | |
| 36 | | |
| | | |
| | | |
| | | |
| | | |
| | | |
| | | |
| | | |

L 15

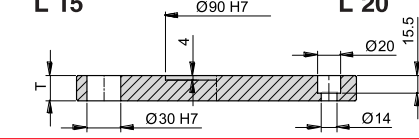

L 20

L 20/246-296

| T | DME 1 1730 | DME 3 2312 |
|----|------------|------------|
| 27 | | |
| 36 | | |
| | | |
| | | |
| | | |
| | | |
| | | |
| | | |
| | | |

L 25/246-296

| T | K | DME 1 1730 | DME 3 2312 |
|----|------|------------|------------|
| 22 | 15.5 | | |
| 27 | 15.5 | | |
| | | | |
| | | | |
| | | | |
| | | | |
| | | | |
| | | | |
| | | | |

L 25

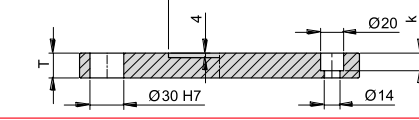

L 30

L 30/246-296

| T | k | DME 1 1730 | DME 3 2312 |
|----|------|------------|------------|
| 17 | 13 | | |
| 22 | 15.5 | | |
| 27 | 15.5 | | |
| | | | |
| | | | |
| | | | |
| | | | |
| | | | |
| | | | |

L 35/246-296

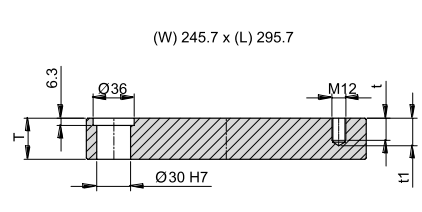

| T | t | t1 | Mat/Mar DME 1 1730 | Mat/Mar DME 4 2162 | Mat/Mar DME 26 2764 | Mat/Mar DME 6 2767 | Mat/Mar DME 11 Stavax ESU* | Mat/Mar DME 10 Ramax S | Mat/Mar DME 7 2311 | Mat/Mar DME 3 2312 | Mat/Mar DME 25 2343 |
|-----|----|----|--------------------|--------------------|---------------------|--------------------|----------------------------|------------------------|--------------------|--------------------|---------------------|
| 17 | 12 | 16 | | | | | | | | | |
| 22 | 14 | 19 | | | | | | | | | |
| 27 | 20 | 25 | | | | | | | | | |
| 36 | 20 | 25 | | | | | | | | | |
| 46 | 20 | 25 | | | | | | | | | |
| 56 | 20 | 25 | | | | | | | | | |
| 66 | 20 | 25 | | | | | | | | | |
| 76 | 20 | 25 | | | | | | | | | |
| 86 | 20 | 25 | | | | | | | | | |
| 96 | 20 | 25 | | | | | | | | | |
| 116 | 20 | 25 | | | | | | | | | |

L 40/246-296

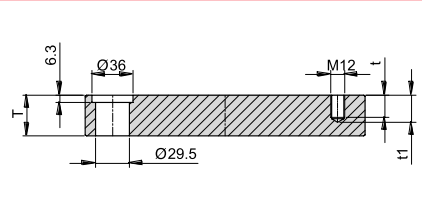

| T | t | t1 | Mat/Mar DME 1 1730 | Mat/Mar DME 4 2162 | Mat/Mar DME 26 2764 | Mat/Mar DME 6 2767 | Mat/Mar DME 11 Stavax ESU* | Mat/Mar DME 10 Ramax S | Mat/Mar DME 7 2311 | Mat/Mar DME 3 2312 | Mat/Mar DME 25 2343 |
|-----|----|----|--------------------|--------------------|---------------------|--------------------|----------------------------|------------------------|--------------------|--------------------|---------------------|
| 17 | 12 | 16 | | | | | | | | | |
| 22 | 14 | 19 | | | | | | | | | |
| 27 | 20 | 25 | | | | | | | | | |
| 36 | 20 | 25 | | | | | | | | | |
| 46 | 20 | 25 | | | | | | | | | |
| 56 | 20 | 25 | | | | | | | | | |
| 66 | 20 | 25 | | | | | | | | | |
| 76 | 20 | 25 | | | | | | | | | |
| 86 | 20 | 25 | | | | | | | | | |
| 96 | 20 | 25 | | | | | | | | | |
| 116 | 20 | 25 | | | | | | | | | |

L 45/246-296

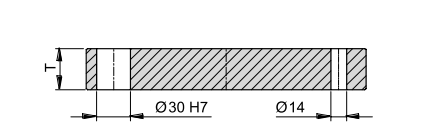

| T | t | t1 | Mat/Mar DME 1 1730 | Mat/Mar DME 4 2162 | Mat/Mar DME 26 2764 | Mat/Mar DME 6 2767 | Mat/Mar DME 11 Stavax ESU* | Mat/Mar DME 10 Ramax S | Mat/Mar DME 7 2311 | Mat/Mar DME 3 2312 | Mat/Mar DME 25 2343 |
|----|---|----|--------------------|--------------------|---------------------|--------------------|----------------------------|------------------------|--------------------|--------------------|---------------------|
| 36 | | | | | | | | | | | |

L 50/246-296

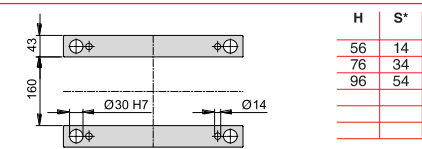

| H | S* | DME 1 1730 |
|----|----|------------|
| 56 | 14 | |
| 76 | 34 | |
| 96 | 54 | |

L 51/246-296

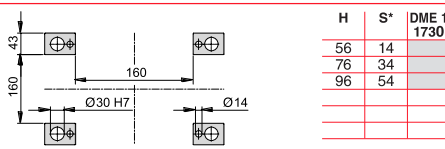

| H | S* | DME 1 1730 |
|----|----|------------|
| 56 | 14 | |
| 76 | 34 | |
| 96 | 54 | |

L 55/246-296

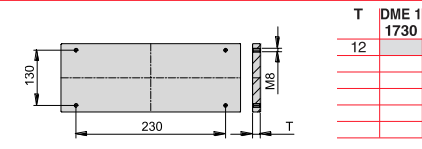

| T | DME 1 1730 |
|----|------------|
| 12 | |

L 56/246-296

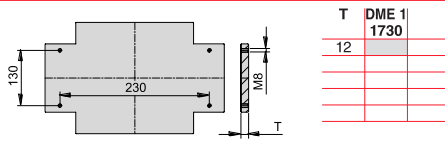

| T | DME 1 1730 |
|----|------------|
| 12 | |